

Two-Stage Step-up Converter with Different Voltage Transformation Ratios depending on the Duty Cycle

Felix A. Himmelstoss, Helmut L. Votzi

Faculty of Electronic Engineering and Entrepreneurship
 University of Applied Sciences Technikum Wien
 Hoehstaedtplatz 6, 1200 Wien (Austria)

Phone: 0043 664 3930428, e-mail: felix.himmelstoss@technikum-wien.at, helmut.votzi@technikum-wien.at

Abstract. A two-stage converter with high output voltage ratio and reduced current stress of the inductors and partly reduced voltage stress is discussed. The function is explained with the help of voltage and current diagrams. The voltage transformation ratio changes between a quadratic step-up for duty cycles lower 0.5 and a double Boost converter for duty cycles higher than 0.5. Dimensioning hints, the control law for feed-forward controls, the transient when the supply is turned on is discussed and some simulations are given. A comparison to other two-stage converters is also treated.

Key words. Quadratic boost, double boost converter, feed-forward control, start-up.

1. Introduction

A comprehensive review of voltage-boosting techniques with a reference list of 309 items can be found in [1]. Basics can be found in the text books e.g. [2, 3]. For our paper especially relevant is [4]. Other interesting papers which all have further references are e.g. [5-13]. In our paper a converter which has, depending on the duty cycle, two different voltage transformation ratios, is treated. Another interesting aspect is the partly reduced voltage stress across the semiconductors and the halved currents through the coils.

Fig. 1 shows the converter. It consists of two electronic switches (S_1, S_2), two diodes (D_1, D_2), two inductors (L_1, L_2), and two capacitors (C_1, C_2).

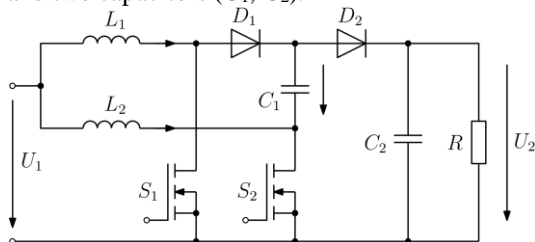

Fig. 1. Two-stage Boost converter.

2. Converter in the steady-state

First we study the converter in the steady-state. Both transistors are controlled with control signals which are

shifted by 180° and with a duty cycle of two thirds. Fig. 2 shows the control signals.

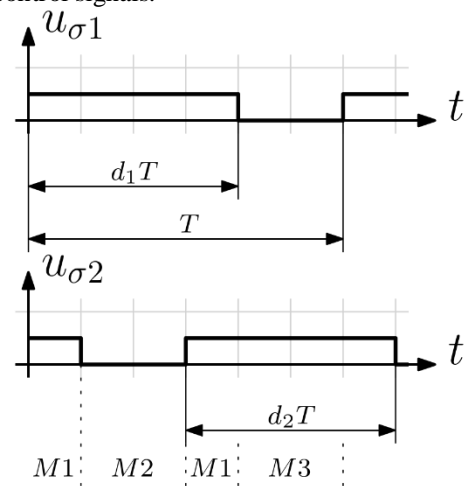

Fig. 2. Control signals.

One can see that one period consists of four modes, two of them are equal. During mode M1 both electronic switches are turned on and the diodes are off. During M2 S_1 is still conducting and D_2 is turned on. When S_2 is turned on again, the converter is again in mode M1. When S_1 is turned off, the converter changes into mode M3 where only S_2 is conducting and the diode D_1 takes over the current through L_1 and D_2 is off.

A. Voltage transformation ratio and voltage stress across the semiconductors

The voltage transformation ratio of the converter can be easily found by investigating the voltages across the inductors. The mean value of these voltages must be zero in the steady-state. Fig. 3 shows the voltages across the coils.

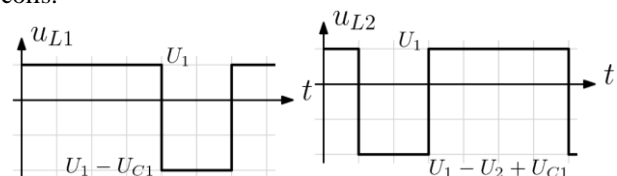

Fig. 3. Voltages across the inductors.

From the voltage-time balance at the inductors L_1 and L_2

$$U_1 d = |U_1 - U_{C1}|(1-d) \quad (1)$$

$$U_1 d = |U_1 - U_2 + U_{C1}|(1-d) \quad (2)$$

one gets

$$\frac{U_{C1}}{U_1} = \frac{1}{1-d} \quad (3)$$

$$M = \frac{U_2}{U_1} = \frac{2}{1-d} \quad (4)$$

The converter is a double Boost converter. Now it is easy to get the voltage stress of the semiconductors. Fig. 4 shows the voltages across the electronic switches.

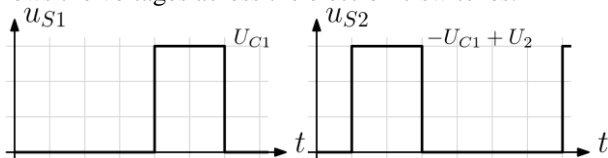

Fig. 4. Voltages across the electronic switches.

The maximum voltage across the electronic switches is only half of the output voltage. This is a decisive improvement upon the normal Boost converter. Looking on the voltages across the diodes leads to the sketches shown in Fig. 5.

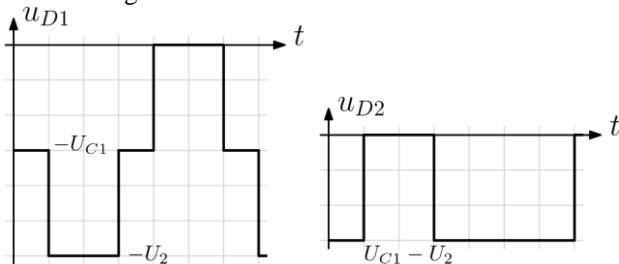

Fig. 5. Voltages across the diodes.

The stress across the output diode D_2 is also only half of the output voltage, the stress across D_1 , however, is equal to the output voltage. Therefore, only one diode must withstand the output voltage, the other diode must only withstand half of it. It is clear that the maximum voltage of the semiconductors must be chosen higher using a security factor.

B. Connection between the currents

The currents through the capacitors must be zero in the mean in steady-state. Therefore, one has to consider the currents through the capacitors first. One has to start with C_2 . Only when S_2 is turned off, the diode D_2 is conducting. When D_2 is off, the load must be supplied by the capacitor C_2 . Looking at C_1 shows that during mode M2 the negative current through L_2 flows through it, and during M3 the current through L_1 has commutated into C_1 . Fig. 6 shows these connections.

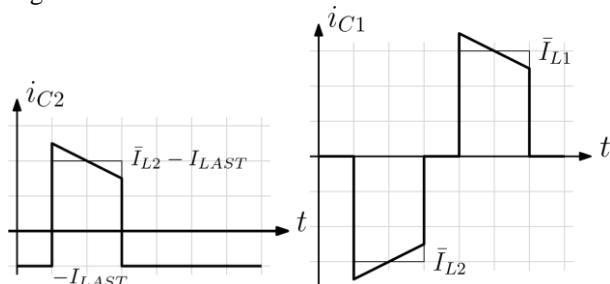

Fig. 6. Current through the capacitors.

The connection between the mean values of the inductor currents and the load current can be calculated according to the charge balances

$$|-I_{Load}|d = (\bar{I}_{L2} - I_{Load})(1-d) \quad (5)$$

$$|\bar{I}_{L2}|(1-d) = \bar{I}_{L1}(1-d) \quad (6)$$

It is evident that the mean values of the currents through the inductors are equal and dependent on the load current according to

$$\bar{I}_{L1} = \bar{I}_{L2} = \frac{I_{Load}}{1-d} \quad (7)$$

The currents through the semiconductors can now be drawn according to Fig. 7 for the electronic switches and to Fig. 8 for the diodes, respectively.

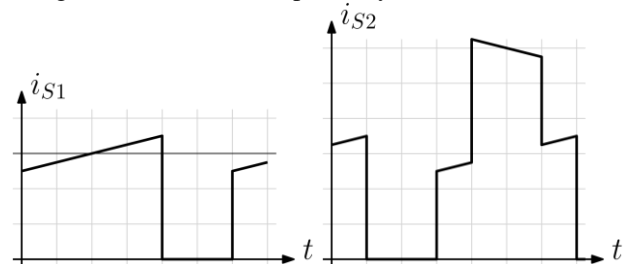

Fig. 7 Currents through the active switches.

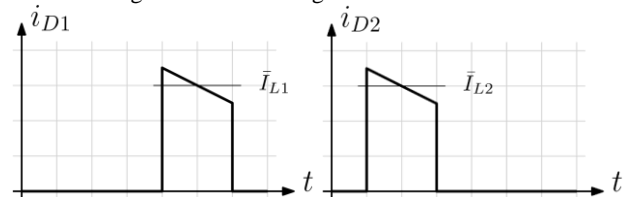

Fig. 8 Currents through the passive switches.

The sum of the currents through the coils is equal to the input current. The load current is equal to the mean value of the current through the output diode D_2 . Fig. 9 depicts the input current, the currents through the coils, and the load current.

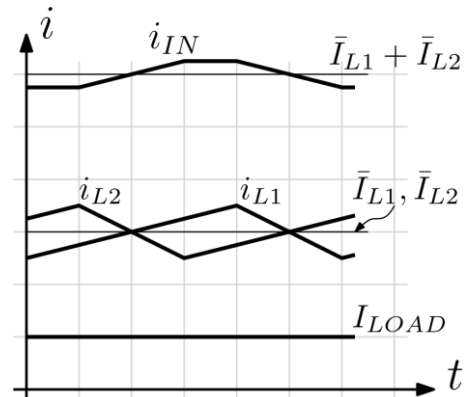

Fig. 9. Up to down: input current, currents through the coils, load current.

C. Converter with a duty cycle of lower 0.5

The two-state converter with the enhanced voltage transformation ratio will be used when high voltage step-up is necessary, otherwise a one stage converter would be used. Therefore, the function of the converter was discussed for a duty cycle of greater than 0.5. For a lower duty cycle than 0.5, again one period consists of four

modes. In mode M1 switch S_1 is on and S_2 is off. In the continuous inductor current mode diode D_1 is off and D_2 is on. Mode M2 starts when S_1 is turned off, now both electronic switches are off and both diodes must conduct. When S_2 is turned on, mode M3 begins. S_1 is still off, D_2 turns off and D_1 continuous to conduct. When S_2 is turned off, the fourth time segment of the period starts which is equal to M2. Mode M1 and M3 both last dT , the weighing of M2 is $(1-2d)T$. The use of the voltage-time balances for the inductors

$$U_1 d = (U_2 - U_1)(1 - 2d) + (U_{C1} - U_1)d \quad (8)$$

$$U_1 d = (U_2 - U_1 - U_{C1})(1 - d) \quad (9)$$

leads to the voltage transformation ratio

$$M = \frac{U_2}{U_1} = \frac{1}{(1-d)^2} \quad (10)$$

and for the voltage across the intermediate capacitor to

$$U_{C1} = \frac{d}{(1-d)^2} U_1 \quad (11)$$

For a duty cycle lower than 0.5 the converter works as a quadratic step-up converter with limited duty cycle!

The control law for the converter with the reference value U_2^* can be calculated according to

$$d = 1 - \sqrt{\frac{U_1}{U_2^*}} \quad (12)$$

Fig. 10 shows the voltages across the inductors, the input current, the current through the inductors, the load current, the output voltage, the input voltage, the voltage across the intermediate capacitor, and the control signals.

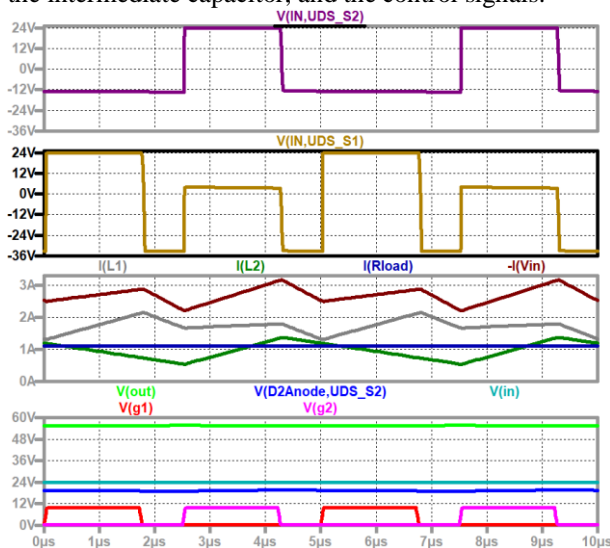

Fig. 10. Up to down: voltage across L_2 ; voltage across L_1 ; input current, current through L_1 , current through L_2 , load current; output voltage, input voltage, intermediate capacitor voltage, control signals.

3. Dimensioning hints

The duty cycle d for both electronic switches is the same. During the on time of the switches, the input voltage lies across the inductors. From the voltage transformation ratio (4) one gets for the duty cycle

$$d = \frac{U_2 - 2U_1}{U_2} \quad (13)$$

With a chosen ripple of the inductor current ΔI_L and the switching frequency f , one gets the equation for the inductors according to

$$L = U_1 \frac{U_2 - 2U_1}{U_2 \cdot \Delta I_L \cdot f} \quad (14)$$

When the switch S_2 is turned on, the diode D_2 is off. Therefore, the load is supplied by C_2 alone. The voltage of it decreases by the value ΔU_{C2} . One can now calculate the value of C_2 according to

$$C_2 = \frac{(U_2 - 2U_1) I_{Load}}{U_2 \cdot \Delta U_{C2} \cdot f} \quad (15)$$

The voltage across C_1 decreases during the off-time by ΔU_{C1} . For a desired ΔU_{C1} one gets for the minimum capacitor

$$C_1 = \frac{I_{Load}}{\Delta U_{C1} \cdot f} \quad (16)$$

4. Turn on of the input voltage

An important aspect for all converters is the question “what happens, when the input voltage is applied to it?”. Two applications are especially interesting: first the converter is supplied by a solar generator or another current limiting source and second it is supplied by a source with low impedance e.g. a battery in a car or in a strong DC-grid. When an input source with a low output impedance is used, a large charging impulse occurs.

A. turn on of a current limiting source

In this case the current cannot exceed the short-circuit value of e.g. the solar generator. Two current loops which form resonant circuits exist. One with a lower frequency consisting of L_1 and the output capacitor C_2 , which is typically larger than the intermediate capacitor C_1 , and one which is formed of L_2 and the series connection of C_1 and C_2 .

B. turn on of a low impedance source

When the voltage is applied to an ideal resonant circuit, the voltage across the capacitor increases up to the double value of the applied voltage. In our case both diodes turn on and the input voltage is applied to the resonant circuit consisting of L_1 and C_2 . The input voltage is also applied to the other resonance circuit consisting of the series connection of L_2 , C_1 and C_2 . Therefore, the voltage across C_1 starts in the negative (that is the wrong) direction. When electrolyte capacitors are used, this will lead to a break-through of C_1 and the voltage is limited at a constant negative value. When D_2 turns off - this happens: When the currents through the inductors compensate each other (the current through L_2 is now already negative) - the voltage increases across C_1 .

The turn-on process can be described by three stages. Immediately after applying the input source to the converter, stage Z1 occurs. Both diodes turn on (both switches are off and the small parasitic capacitors of them are neglected). With the help of the state-space description a fourth order system has to be solved. A better way to get the results is to use the mesh current method.

For Z1 one has three meshes and therefore three mesh currents. Two mesh currents are identical with the inductor currents, so we use as variables i_{L1} and i_{L2} . The third mesh current is called i_3 . The mesh equations are therefore

$$U_1 = L_1 \frac{di_{L1}}{dt} + \frac{1}{C_2} \int_0^t i_{L1} dt. \quad (17)$$

$$U_1 = L_1 \frac{di_{L2}}{dt} + \frac{1}{C_1} \int_0^t i_{L2} dt + \frac{1}{C_2} \int_0^t i_{L2} dt \quad (18)$$

$$L_1 \frac{di_3}{dt} + \frac{1}{C_1} \int_0^t i_3 dt + L_2 \frac{di_3}{dt} = 0 \quad (19)$$

The third mesh equation (19) results in i_3 and is equal to zero. For the mesh currents (which are equal to i_{L1} and i_{L2}) one gets

$$i_{L1} = U_1 \sqrt{\frac{C_2}{L_1}} \sin\left(\sqrt{\frac{1}{C_2 L_1}} t\right) \quad (20)$$

$$i_{L2} = U_1 \sqrt{\frac{C_1 C_2}{L_2 (C_1 + C_2)}} \sin\left(\sqrt{\frac{C_1 + C_2}{C_1 C_2 L_2}} t\right). \quad (21)$$

The voltage across the output can be calculated with

$$u_{C2} = \frac{1}{C_2} \int_0^t (i_{L1} + i_{L2}) dt. \quad (22)$$

These results are valid until D_2 turns off. This happens when the current through D_2 reaches zero

$$i_{L1} + i_{L2} = 0 = \quad (23)$$

$$U_1 \sqrt{\frac{C_2}{L_1}} \sin\left(\sqrt{\frac{1}{C_2 L_1}} t\right) + U_1 \sqrt{\frac{C_1 C_2}{L_2 (C_1 + C_2)}} \sin\left(\sqrt{\frac{C_1 + C_2}{C_1 C_2 L_2}} t\right).$$

This equation can be solved numerically or graphically and one can now calculate the initial condition for stage Z2.

When the diode D_2 turns off, only mesh 3 is effective. One can write for the mesh current i_3 in this second stage Z2

$$L_1 \frac{di_3}{dt} + \frac{1}{C_1} \int_0^t i_3 dt + u_{C1}(T_1) + L_2 \frac{di_3}{dt} = 0. \quad (24)$$

The two inductors are in series and the current through them must be zero at the beginning

$$(L_1 + L_2) \frac{di_3}{dt} + \frac{1}{C_1} \int_0^t i_3 dt + u_{C1}(T_1) = 0. \quad (25)$$

The state variables can easily be calculated from the mesh current i_3 according to

$$i_{L1} = i_3. \quad (26)$$

$$i_{L2} = -i_3. \quad (27)$$

$$u_{C1} = \frac{1}{C_1} \int_0^t i_3 dt + u_{C1}(T_1). \quad (28)$$

Mode Z2 ends, when the current through the diode D_1 reaches zero after the time interval T_2 .

When D_1 turns off, D_2 turns on again and stage Z3 begins. Now the mesh current which is equal to i_{L2} is effective and leads to (29) which follows here

$$U_1 = L_2 \frac{di_{L2}}{dt} + \frac{1}{C_1} \int_0^t i_{L2} dt + u_{C1}(T_2) + \frac{1}{C_2} \int_0^t i_{L2} dt + u_{C2}(T_2).$$

With the help of Laplace transformation one gets

$$i_{L2}(t) = [U_1 - u_{C1}(T_2) - u_{C2}(T_2)] \sqrt{\frac{C_1 C_2}{(C_1 + C_2) L_2}} \cdot \sin\left(\sqrt{\frac{C_1 + C_2}{C_1 C_2 L_2}} t\right). \quad (30)$$

This mode ends when the current reaches zero and D_2 turns off again.

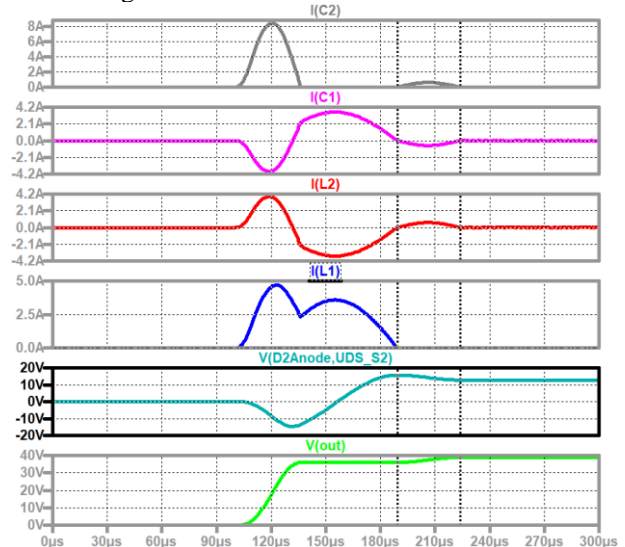

Fig. 11. Turn-on of the input voltage, up to down: current through output capacitor C_2 , current through intermediate capacitor C_1 , current through L_2 , current through L_1 , voltage across C_1 , and output voltage.

Inspecting Fig. 1 one can conclude that the stationary values of the capacitors (the electronic switches do not work now) will be a little bit lower than the input voltage (when the voltage across C_2 gets lower than the input voltage, the diodes turn on and charge again C_2) for the output capacitor C_2 and nearly zero for C_1 . Fig. 11 shows a simulation.

5. Start-up and feed-forward control

For a desired output voltage U_2^* one can write for the control law

$$d = \frac{U_2^* - 2U_1}{U_2^*}. \quad (31)$$

To get a positive duty cycle the reference value must be greater than two times the input voltage. Fig. 12 shows the reference value and the currents through the inductors in the upper picture and in the lower one the reference value, the output voltage, the voltage across the intermediate capacitor, and the input voltage. After 0.5 ms the input voltage is turned on. One can see that after a short time the output voltage is a little bit lower than the input voltage. After 3 ms the reference value starts to ramp up and about 2 ms later the feed-forward controller starts to work. The output voltage reaches the reference value after about 3.5 ms. From now on the output voltage follows the reference value. At 15 ms there is a step in the reference value. There is now a short transient. At 20 ms one can see an input voltage step which again leads to a transient.

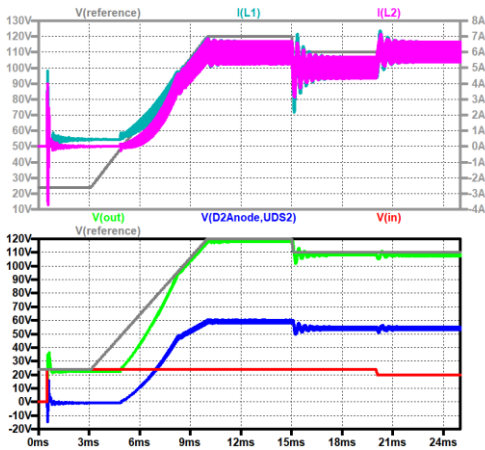

Fig. 12. Up to down: reference value (grey) and the currents through the inductors (violet and turquoise) in the upper picture and reference value (grey), the output voltage (green), the voltage across the intermediate capacitor (blue), and the input voltage (red) in the lower one.

More details concerning the design of the feed-forward control can be found in [14].

6. Comparison to other two-stage Boost converters

In this section other two-stage Boost converter topologies are treated.

A. Interleaved Boost converter with only one diode

This converter (Fig. 13) splits the energy of the input into two parts. So the currents through the inductors and through the electronic switches are reduced. Both transistors and the diode must block the output voltage. The voltage-time balance across the inductors

$$U_1 \cdot 2d = |U_1 - U_2|(1 - 2d) \quad (32)$$

leads to the voltage transformation ratio

$$M = \frac{U_2}{U_1} = \frac{1}{1 - 2d} \quad \text{with } d < 0.5 \quad (33)$$

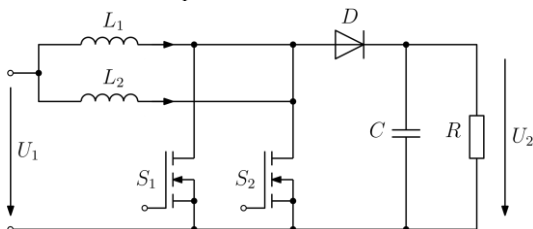

Fig. 13. Interleaved Boost converter with only one diode.

The voltage stress across the semiconductors is equal to the output voltage. The input current is shared into the two inductor currents. One has to keep in mind that the duty cycle of the electronic switches must be lower than about 0.4. In reality one also has to control the symmetry of the inductor currents.

Fig. 14 shows the currents through the inductors (which differ in their values by 10 %), the input current, and the load current. The lower diagram shows the output voltage and the control signals of the active switches.

The clocks are interleaved and the input current and both inductors have a frequency which is doubled (in our case 400 kHz)!

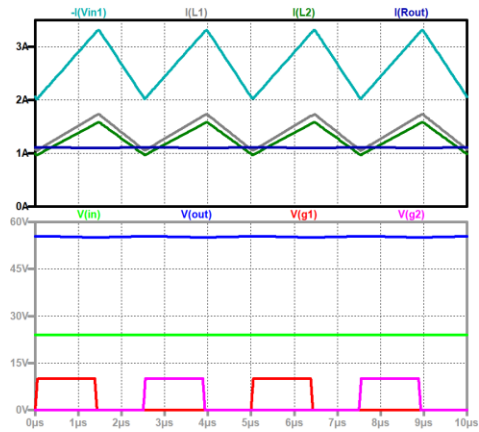

Fig. 14. Up to down: input current (turquoise), currents through the inductors (grey and dark green), load current (dark blue); output voltage (blue), input voltage (green), control signals.

B. Interleaved Boost converter with two diodes

The two converters work really completely in parallel (Fig. 15). To increase the frequency of the input current (double it), the control signals for the transistors are shifted by 180°.

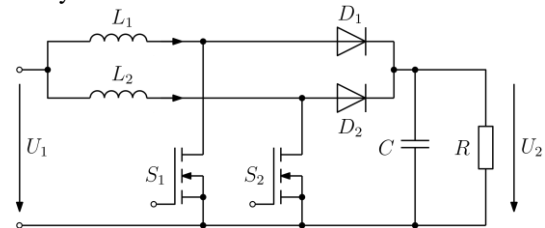

Fig. 15. Interleaved Boost converter with two diodes

The voltage transformation ratio M is the same as for a normal Boost converter.

$$M = \frac{U_2}{U_1} = \frac{1}{1 - d} \quad (34)$$

The advantage of this concept is that the handled energy is split. The voltage stress of the devices, however, is equal to that of the normal Boost converter.

Fig. 16 shows the currents through the inductors (which differ in their values by 10 %), the input current is equal to the current through L_1 , and the load current. The lower diagram shows the output voltage, and the control signals of the active switches.

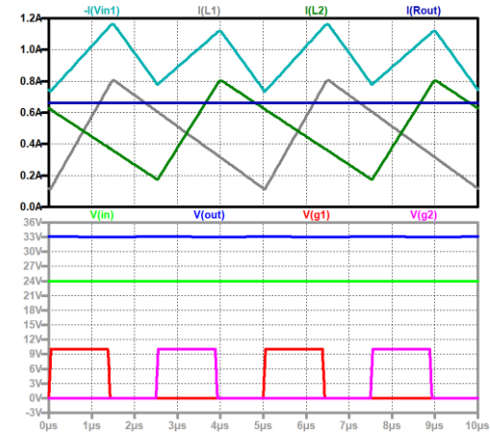

Fig. 16. Up to down: input current (turquoise), currents through the inductors (grey and dark green), load current (dark blue); output voltage (blue), input voltage (green), control signals.

C. Cascaded Boost

The cascaded Boost converter (Fig. 17) consists of two cascaded Boost stages. The voltage across C_1 is therefore

$$U_{C1} = \frac{1}{1-d_1} U_1. \quad (35)$$

This leads to the voltage transformation ratio according to

$$\frac{U_2}{U_1} = \frac{1}{(1-d_1)(1-d_2)}. \quad (36)$$

Using the same duty cycle for both stages one can write

$$\frac{U_2}{U_1} = \frac{1}{(1-d_1)^2}. \quad (37)$$

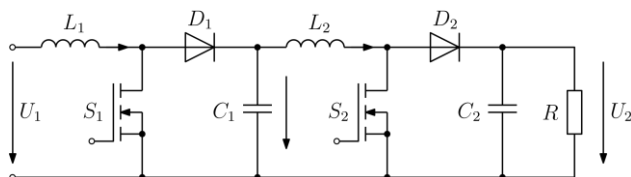

Fig. 17. Cascaded Boost converter.

The cascaded boost converter is a quadratic converter and especially useful for higher voltage transformation ratios. A disadvantage compared with the here treated converter (Fig. 1) is that both stages have to transfer the whole power and not only half of the power. Furthermore, the voltage stress of the semiconductors of the second stage is equal to the output voltage.

Fig. 18 shows the currents through the inductors (which differ in their values by 10 %), the input current is equal to the current through L_1 , and the load current. The lower diagram shows the output voltage, the voltage across the intermediate capacitor, and the control signals of the active switches.

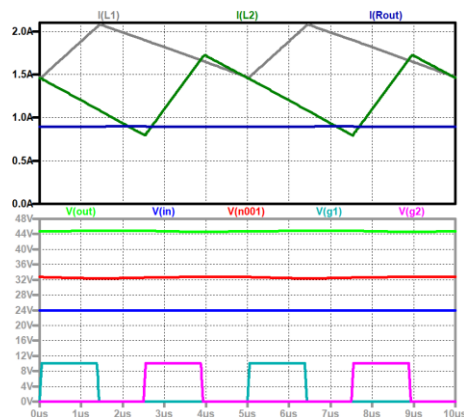

Fig. 18. Up to down: currents through the inductors (grey and brown), load current (dark blue); output voltage (green), voltage across intermediate capacitor (red), input voltage (blue), control signals.

7. Conclusion

A two-stage converter with two voltage transformation ratios depending on the duty cycle was analyzed. The converter is a quadratic step-up converter when the duty cycle is lower than 0.5 and has a double boost characteristic for duty cycles higher than 0.5. The stress of the semiconductor devices is reduced. The converter is

especially useful for solar, fuel cell, battery, and micro grid applications.

References

- [1] M. Forouzesh, Y. P. Siwakoti, S. A. Gorji, F. Blaabjerg and B. Lehman, "Step-Up DC-DC Converters: A Comprehensive Review of Voltage-Boosting Techniques, Topologies, and Applications," in *IEEE Transactions on Power Electronics*, vol. 32, no. 12, pp. 9143-9178, Dec. 2017, doi: 10.1109/TPEL.2017.2652318.
- [2] F. Zach, *Power Electronics (Leistungselektronik, in German)*, 6th edition, Springer: Wien-NewYork 2022.
- [3] N. Mohan, T. Undeland and W. Robbins: *Power Electronics, Converters, Applications and Design*, 3rd ed. New York: W. P. John Wiley & Sons, 2003
- [4] Y. Zheng, W. Xie and K. M. Smedley, "A Family of Interleaved High Step-Up Converters With Diode-Capacitor Technique," in *IEEE Journal of Emerging and Selected Topics in Power Electronics*, vol. 8, no. 2, pp. 1560-1570, June 2020, doi: 10.1109/JESTPE.2019.2907691.
- [5] M. Bhaskar, R. Girish Ganesan and K. Narayanan, "Interleaved Hybrid Boost Converter with Switched Capacitor Technique," 2019 *IEEE Innovative Smart Grid Technologies - Asia (ISGT Asia)*, 2019, pp. 3890-3895, doi: 10.1109/ISGT-Asia.2019.8881462
- [6] L. Colalongo, G. Duina, A. Richelli and Z. M. Kovacs-Vajna, "A Modular Boost Converter with Low Switch Stress and High Conversion Ratio for Automotive Applications," 2018 *International Conference of Electrical and Electronic Technologies for Automotive*, 2018, pp. 1-4, doi: 10.23919/EETA.2018.8493186.
- [7] B. Zhu, F. Ding and D. M. Vilathgamuwa, "Coat Circuits for DC-DC Converters to Improve Voltage Conversion Ratio," in *IEEE Transactions on Power Electronics*, vol. 35, no. 4, pp. 3679-3687, April 2020, doi: 10.1109/TPEL.2019.2934726.
- [8] L. Zhang, D. Xu, H. Li, G. Shen and M. Chen, "Three-phase interleaved high step-up boost converter with voltage multiplier for fuel cell power system," 2015 *IEEE Energy Conversion Congress and Exposition (ECCE)*, 2015, pp. 4804-4811, doi: 10.1109/ECCE.2015.7310338.
- [9] G. Wu, X. Ruan and Z. Ye, "Nonisolated High Step-Up DC-DC Converters Adopting Switched-Capacitor Cell," in *IEEE Transactions on Industrial Electronics*, vol. 62, no. 1, pp. 383-393, Jan. 2015, doi: 10.1109/TIE.2014.2327000.
- [10] Z. Saadatizadeh, P. C. Heris, M. Sabahi and E. Babaei, "A DC-DC Transformerless High Voltage Gain Converter With Low Voltage Stresses on Switches and Diodes," in *IEEE Transactions on Power Electronics*, vol. 34, no. 11, pp. 10600-10609, Nov. 2019, doi: 10.1109/TPEL.2019.2900212.
- [11] S. Sadaf, M. S. Bhaskar, M. Meraj, A. Iqbal and N. Al-Emadi, "A Novel Modified Switched Inductor Boost Converter With Reduced Switch Voltage Stress," in *IEEE Transactions on Industrial Electronics*, vol. 68, no. 2, pp. 1275-1289, Feb. 2021, doi: 10.1109/TIE.2020.2970648.
- [12] N. H. Pour and K. Varesi, "A New Non-Isolated High Gain DC-DC Converter Suitable for Renewable Energies," 2019 *10th International Power Electronics, Drive Systems and Technologies Conference (PEDSTC)*, 2019, pp. 747-751, doi: 10.1109/PEDSTC.2019.8697239.
- [13] S. Khan et al., "A New Transformerless Ultra High Gain DC-DC Converter for DC Microgrid Application," in *IEEE Access*, vol. 9, pp. 124560-124582, 2021, doi: 10.1109/ACCESS.2021.3110668.
- [14] F. A. Himmelstoss and H. L. Votzi, "A Floating Double Buck-Boost Converter as Driver for a Permanent Exited DC Machine," 2021 *International Conference on Electrical Drives & Power Electronics (EDPE)*, 2021, pp. 72-77, doi: 10.1109/EDPE53134.2021.9604062.